



**2-Way Communicating Thermostat
Hardware Installation and Operation Manual**



**.....INSTALLERS....
CONTACT LIGHTSTAT FOR ACTIVATION
1-800-292-2444**

**Intended for connection to
Class 2 Circuit(s) Only (24 VAC)
Common Wire is Required**

**Manufactured by:
Lightstat Inc.
Barkhamsted, CT
www.lightstat.com**

For e-Stat® Model Thermostat

e-Stat Typical Wiring Configuration

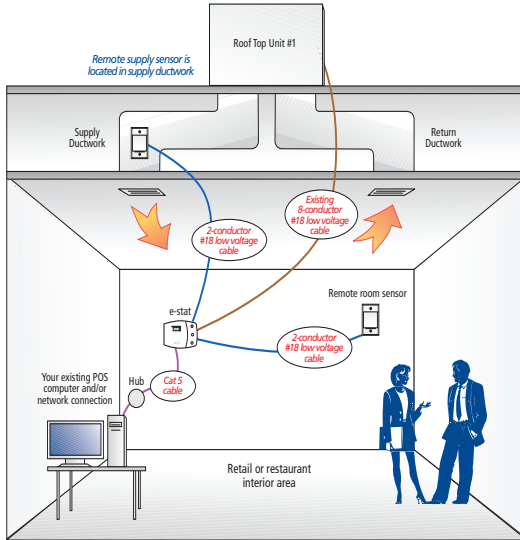

1. Typically, the e-Stat should be located within a few feet of the network equipment such as the network switch. It may be located farther. The maximum Cat 5 cable run is 328 ft (100 meters).
2. Mount the **Remote Room Sensor** on a wall or column in the conditioned space, away from windows, doors and supply air ducts. (Refer to page 9 for more instructions.)
3. Mount the **Supply Air Sensor** in the supply air duct as close to the HVAC unit as possible. (Refer to page 10 for more instructions.)

Note: You must use the remote temperature sensor supplied. The e-Stat does NOT contain an onboard temperature sensor.

Description:

The e-Stat is a low voltage, solid state, automatic changeover, heating/cooling thermostat with digital display showing setpoints and room temperature.

The e-Stat is a 2-Way Communicating, *remotely programmable* thermostat.

Standard Features:

- Control of up to two stages of heating and cooling.
- Proportional plus Integral (P+I) control for accurate, even temperature control.
- Automatic changeover from heating to cooling with deadband to prevent short cycling of HVAC equipment.
- Remotely programmable, adjustable deadband.(5 °F is default)
- Remotely configurable Y1, Y2 interstage differential (1.5 °F is default)
- Intelligent pre-conditioning of the controlled space prior to the start of the workday.
- Automatic randomized delay to prevent power surges at power up (4 to 12 minutes)
- Backlit display for easy viewing in low light conditions.
- Support for optional humidity sensing.
- Limited Lifetime Warranty.

General:

Voltage Rating (min, max).....20 to 30 VAC
Current Draw (typ).....285 mA @ 24VAC
A1-A2-A3 Relay Load (max).....1 Amp @ 24VAC
G, Y1, Y2, W1, W2, O/B Load (max)...1 Amp @24VAC

Network:

Cabling.....Cat5 (UTP) with RJ45 connector
Ethernet.....10/100BT Auto-Sensing
Wiring Cable Distance (Max).....328 ft

Inside View - Door (Left)

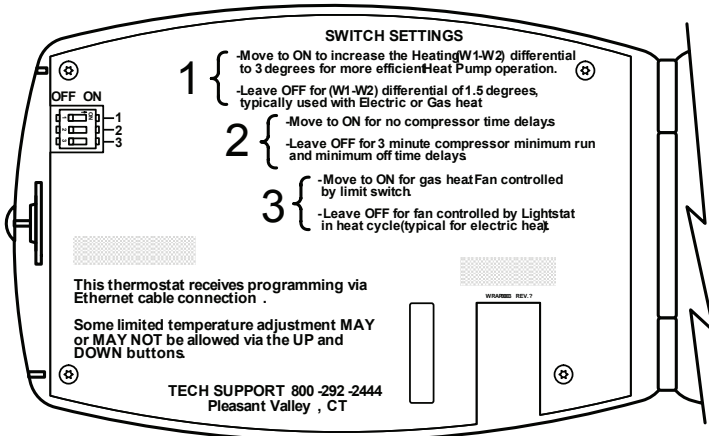

Inside View - Base (right)

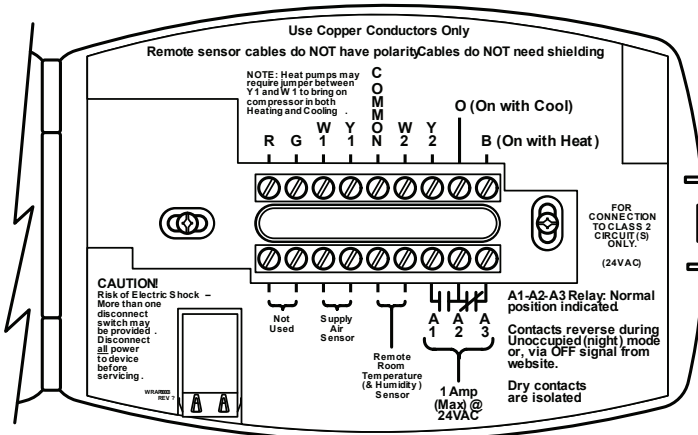

Connecting the Outputs

Caution: Risk of Electrical Shock - More than one disconnect switch may be provided. Disconnect all power to device before servicing.

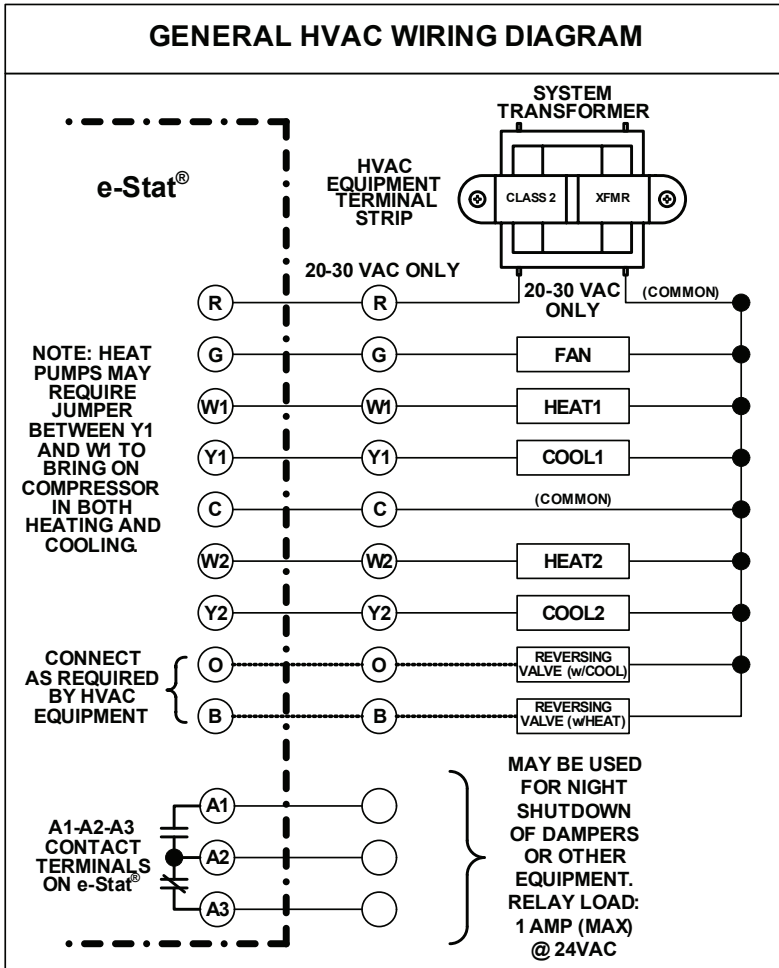

Remove the old thermostat from the wall making note of the wire colors on the back of the mounting kit provided. Thread the thermostat cable through the hole in the back of the e-Stat. Mount the e-Stat securely to the wall using the hardware provided. The e-Stat should be leveled for cosmetic reasons.

Connecting the Outputs

R - Hot Wire; one side of the control (20 - 30 VAC) transformer. If two hot wires are present (as with RC and RH) determine if they come from separate transformers. The e-Stat must be installed on a single transformer system.

G - Fan Wire.

W1 - First stage of heating.

Y1 - First stage of cooling.

When conventional rooftop equipment is selected, the interstage differential is always 1.5 °F. With heat pump switch #1 set to "ON", the interstage differential is 3.0 °F for heating stages and 1.5 °F for cooling stages. (If using a humidity sensor, interstage differential will increase during cooling to compensate for high humidity conditions.)

C - Common or Neutral side of transformer. **This must be connected for the e-Stat to operate.**

W2 - Second stage of Heat or Auxiliary heat with heat pumps.

Y2 - Second stage of cooling.

O - This output will be active with a call for cooling. Often used for heat pump reversing valve.

B - This output will be active with a call for heating. (Connect O & B outputs as required by the HVAC equipment.)

Note: Jump W1 and Y1 for heat pumps that have a single compressor wire to bring the compressor on for both heating and cooling.

A1, A2, A3 are dry contact relay terminals that may be used for night shutdown of dampers or control of other equipment. This is a separate relay with isolated contacts.

Front View - Front Door Open

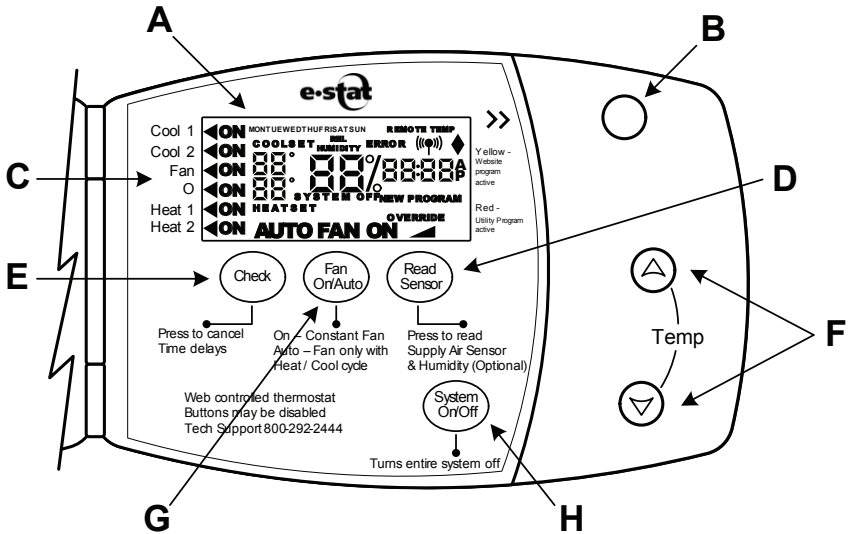

A - Indicates day of the week.

B - Signal/Status L.E.D. Indicators.

C - Output designators.

D - Press once to see supply air temp and “last program” information, 2nd press displays % relative humidity (if a humidity sensor is in use).

E - Check button. Use to cancel time delays.

F - Temperature up/down buttons.

G - Fan On/Auto button.

H - System power button.

Display Designators

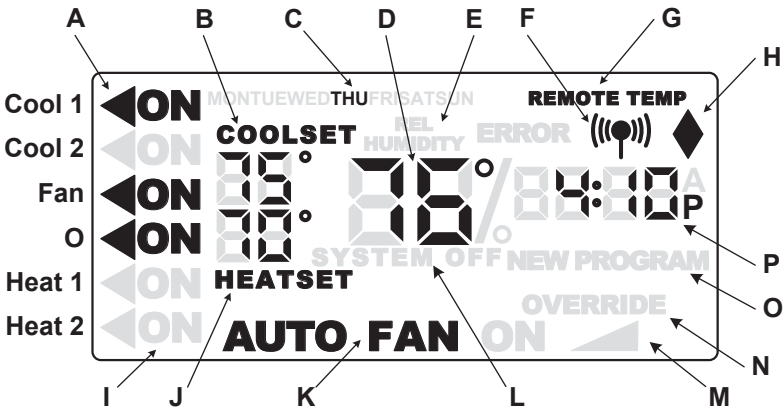

A - Output indicators. Illuminated “ON” and arrow indicates output is active. Flashing arrow and steady “ON” indicates output is being held on by time delay. Flashing arrow alone indicates output is being held off by time delay.

B - Cooling temperature setpoint.

C - Indicates day of the week.

D - Current remote room temperature, supply air temp, or ambient humidity.

E - REL HUMIDITY will flash to indicate setpoint reduction is active.

F - Antenna icon indicates that an ethernet carrier is sensed.

G - Remote temperature sensor indicator.

H - Indicates status of hosting server communications.

I - If arrow and “ON” are not illuminated, the output is off.

J - Heating temperature set point.

K - Fan On/Auto indicator.

L - Indicates system is off.

M - Ramp symbol will be illuminated if space is actively being preheated or precooled.

N - Solid “OVERRIDE” indicates the program has been overridden with the Up/Down buttons if allowed locally. Flashing “OVERRIDE” indicates remote override.

O - “New Program” will illuminate when “Read Sensor” button is pressed once (provided thermostat has been programmed).

P - Indicates AM or PM Local time.

Wiring Layout

The e-Stat is used as a stand-alone thermostat to control a single HVAC system. Do not attempt to control more than one HVAC unit with an e-Stat®

Both Remote Temperature and Supply Air sensors **MUST BE** installed for the e-Stat to function properly.

All wiring should be a minimum of #18AWG. Shielding is **not** required.

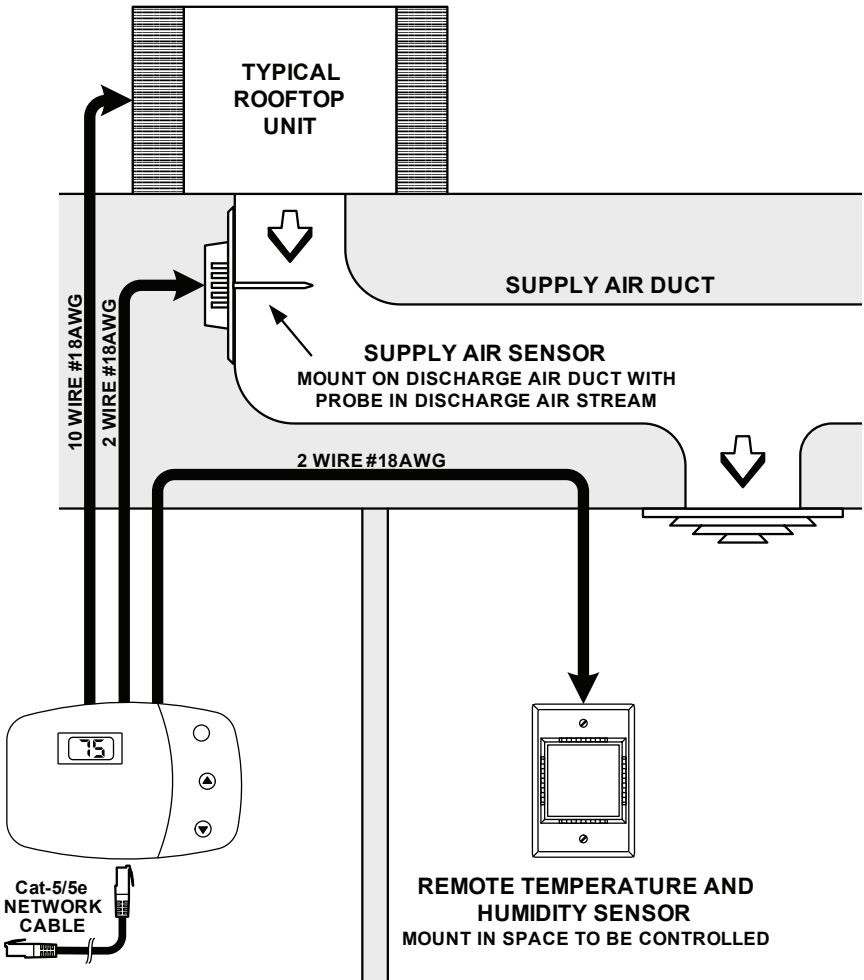

Remote Sensor Installation

The e-Stat must have both a **remote temperature sensor** and a **supply air sensor** installed. These sensors are supplied for each thermostat.

Note: See Appendix B for remote temp and humidity sensor.

Use #18 gauge 2-conductor thermostat cable between the e-Stat and the remote sensors. Remote sensors are unaffected by wire runs of up to 500 feet.

Remote sensors do not have polarity, either wire may be connected to either terminal. Shielded cable is not required for remote sensors.

Mount the remote temperature sensor in the area to be heated and/or cooled. If the remote temperature sensor is installed where the old thermostat was, use the supplied wall plate for cosmetic reasons.

Connect the 2-conductor cable to the two terminals marked Remote Temperature Sensor. These are located in the center of the bottom terminal block as seen in the figure below.

Note that this sensor is not designed to be placed into a moving air stream.

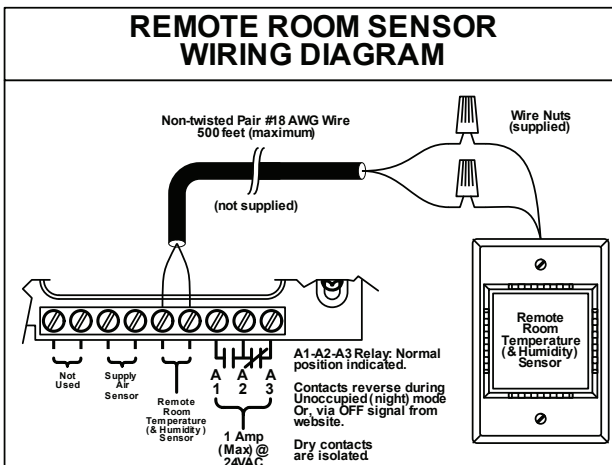

Supply Air Sensor

Mount the Supply Air Sensor on the discharge air duct with the probe in the discharge air stream. The probe must be positioned horizontally or downward. **Do not** place on the bottom of the duct with the probe sticking up. **Do not** use probe as a tool to puncture ductwork.

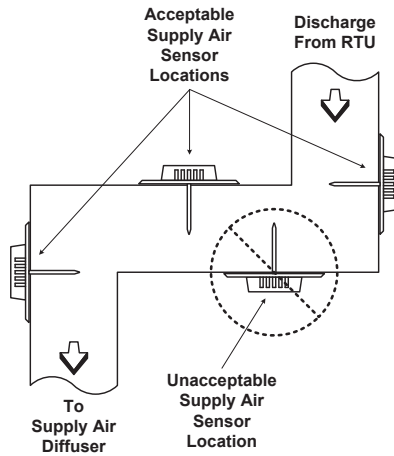

Connect the 2-conductor cable to the two terminals marked Supply Air Sensor. These are located on the bottom terminal block as seen in figure below.

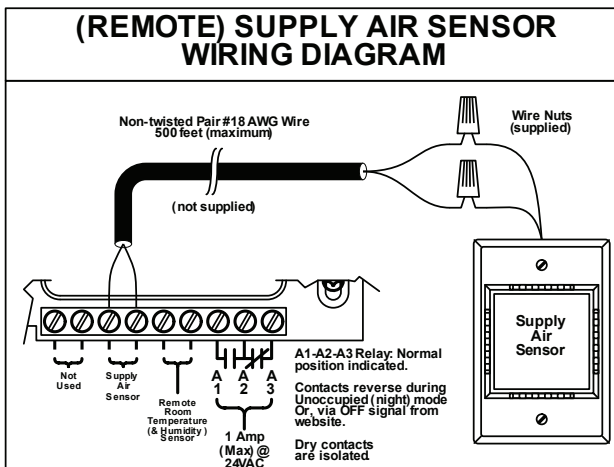

Setting the Heat Pump Switch (#1)

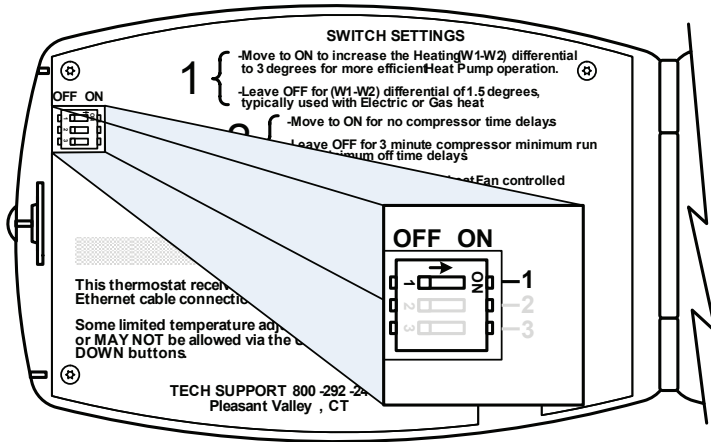

When using the e-Stat on a heat pump, move this switch to the ON position. This will increase the interstage differential between W1 and W2 from 1.5 °F to 3 °F in the heating mode to allow the HVAC to operate the compressor longer before turning on the backup heat.

Moving this switch to ON also tells the e-Stat to use a different intelligent recovery warm up from the unoccupied to the occupied mode, to minimize the use of backup heat.

The recovery period is a maximum of 128 minutes. The e-Stat will automatically determine the amount of time required to bring the space up to the desired temperature setpoint.

During this recovery period, the e-Stat will display the "ramp" symbol in the digital display and the temperature setpoints will ramp automatically.

Setting the Compressor Time Delay Switch (#2)

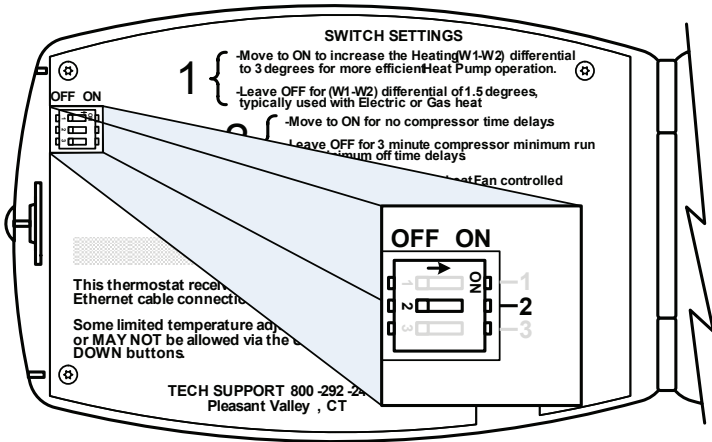

When this switch is set to OFF, the minimum On and Off time for any stage of Heating or Cooling will be 3 minutes.

When set to ON, the minimum On and Off time for any stage of Cooling will be 15 seconds.

In either position, the Fan will continue to run for 45 seconds after the Heating or Cooling stops; unless the Fan switch is set to ON in which case the fan runs continuously.

During night setback the Fan will revert to the Auto Mode.

Setting the Heat Fan switch to Gas/Electric (#3)

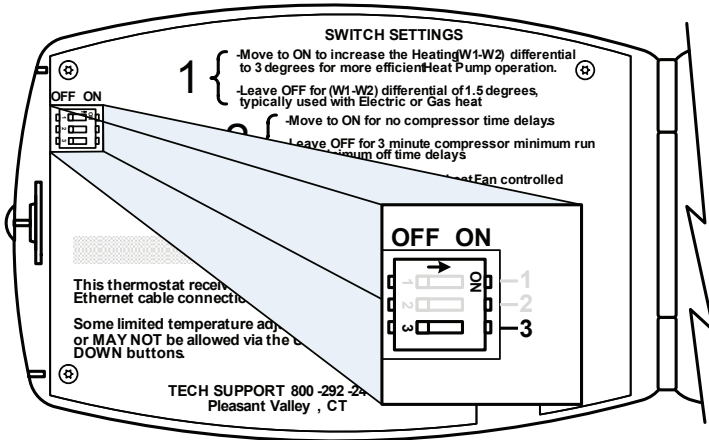

This is often called the “Gas/Electric” switch. Consult the HVAC equipment manufacturers’ instructions for details on how to set this switch.

When controlling fossil fueled equipment with a fan limit control, you may want to set this switch to the ON position.

Note: The e-Stat will not bring on the fan in this setting during the heat cycle.

Leave this switch set to OFF for all other equipment, such as electric heat or heat pumps.

A1-A2-A3 DRY CONTACT CLOSURE WIRING DIAGRAM

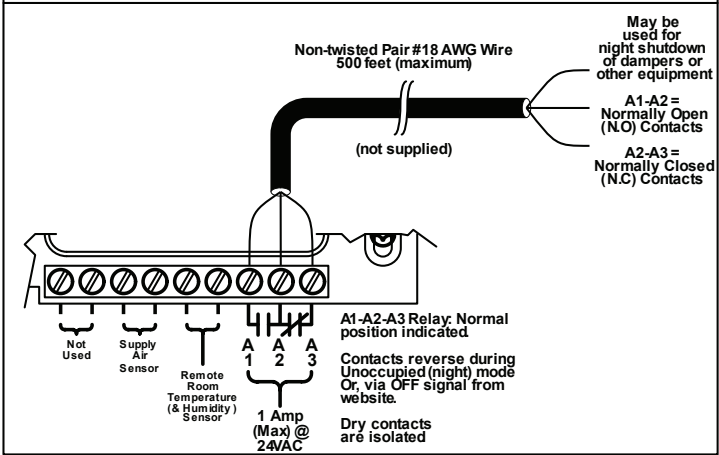

Use #18 gauge cable between the e-Stat and the damper or equipment to be controlled. Cables **do not** need to be shielded.

The A1-A2-A3 terminals are an isolated set of dry contacts rated 1 Amp at 24 VAC.

Connect the cable to the appropriate terminals marked A1-A2-A3. Connect the other end to the damper or equipment to be controlled as needed.

The default operation for A1-A2 is open during “occupied” period and closed during “unoccupied” period. A2-A3 is closed during “Occupied” period and open during “unoccupied” period.

Note: Alternatively, these contacts can be controlled remotely via the Internet. See Appendix A.

Powering up the e-Stat

First you must turn on the breaker or switch that feeds power to your HVAC equipment.

Next, press the blue System On/Off button to turn on the e-Stat.

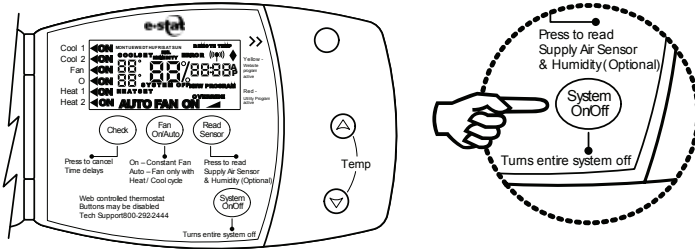

The power-up sequence will give you information about your e-Stat.

IMPORTANT: The e-Stat must be programmed remotely. The thermostat will run the HVAC system on default temperatures. After power up, this thermostat must be activated in order for the customer to change the programming. (see page 16 for activation instructions).

You must connect the Cat 5 RJ45 jack in order for the e-Stat to communicate on the network and be programmed.

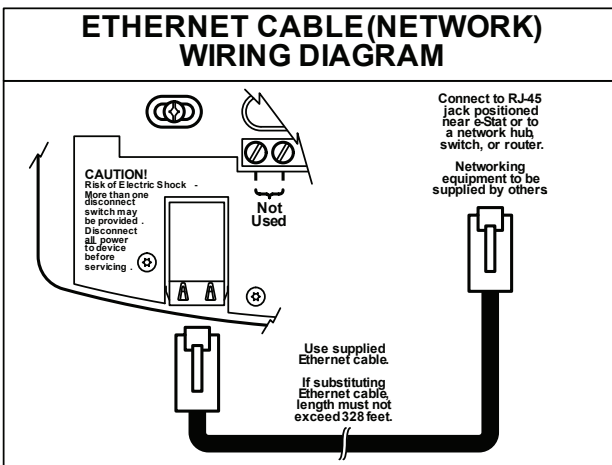

Thermostat Activation

The e-Stat thermostat must be activated after installation. Activation only takes a few minutes.

Information you will need before calling to activate your e-Stat:

1. Location Name, such as restaurant or store name.
2. Store Number.
3. Thermostat TUID number (yellow label affixed on the inside wrap of the thermostat).

During the activation, Lightstat Support will be able to bring on the heating and/or cooling for you to verify proper equipment operation.

Depending on the model e-Stat you have, the temperature buttons may or may not work. If the temperature up/down buttons function, do not use these to test the HVAC operation prior to activation. This will put the e-Stat in override mode. If the word "override" is in the display, you must turn the power off and then back on in order to clear the override.

**PLEASE CALL TO ACTIVATE THE
THERMOSTAT**

1-800-292-2444

**YOUR CUSTOMER CANNOT COMMUNICATE
WITH THE THERMOSTAT UNLESS IT HAS
BEEN ACTIVATED.**

Green Button Functions

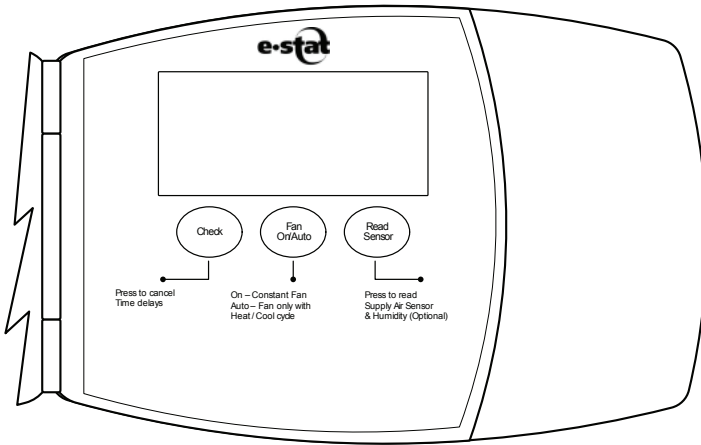

Check - Cancels all time delays (primarily used for troubleshooting purposes).

Fan On/Auto - Some model thermostats may not have a selectable fan function. If selectable, choose between “ON” (Constant Fan) or “AUTO” (Fan only with heat or cool cycle) during OCCUPIED period.

Read Sensor - Press the “Read Sensor” button once to see when the last program was received. This will also display the supply air duct sensor temperature. Press a second time to see the relative humidity (if an RTH sensor is in use).

Setting Temperature

Use the UP and DOWN temperature buttons to change the heating and cooling setpoints. To conserve energy and make sure that the heating and cooling units do not fight each other, the heating and cooling setpoints typically cannot be set closer than 5 °F. Other “ON-OFF differentials” may be used. 3, 4 or 6 °F can be selected via the communications interface.

The range of local temperature adjustment may be restricted to owner specifications.

On some models the temperature buttons may not function.

If the temperature buttons function and they are used, the word “OVERRIDE” will appear in the display. The override period is determined by the communications interface. When the override period expires, the e-Stat will revert back to its program.

Note: Not all e-Stats allow button adjustment of temperature settings during the OCCUPIED period.

During the UNOCCUPIED program period pressing either up or down buttons will adjust the setpoints to the settings defined for the previously occupied state. The previously occupied state setpoints will remain in effect for 2 hours (time frame is adjustable) before reverting back to the setpoints defined in the current program. If previously occupied state data is unavailable for the current day, default temperature settings are used.

Output Status

Your e-Stat will show the status of the HVAC system outputs. It will indicate when the Fan, Heating or Cooling should be running.

When you see “◀” **ON** in the display, the e-Stat® is turning that output on.

A flashing arrow “◀” by itself means the output is being held OFF for a minimum time period.

Note: Use the **CHECK** button to cancel equipment time delays for faster checkout.

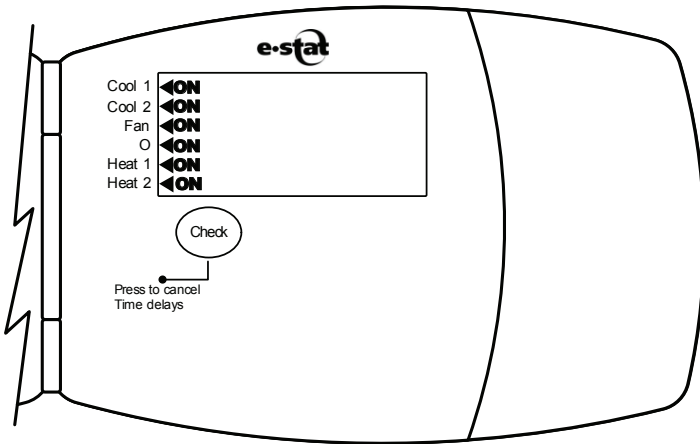

You can use the output indicators to help troubleshoot your HVAC system. If the **Cool 1** and **Cool 2** output indicators are displayed, you should feel cool air coming from the HVAC system. This tells you the HVAC system is working properly. Press “Read Sensor” to see supply air temperature.

Indicator Lights

The e-Stat contains (4) indicating lights:
Yellow Green Blue Red

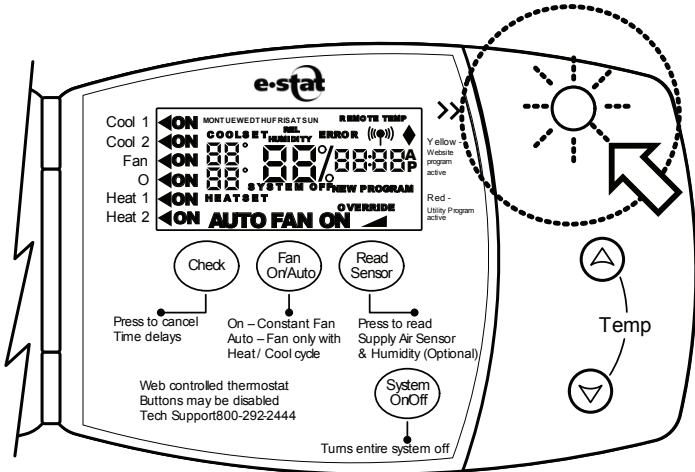

- | | |
|------------------|---|
| Solid Yellow | Time and setpoint program are in effect. |
| Flashing Yellow | Program setpoints have been overridden at thermostat. |
| Flashing Green | No valid program or time; Default setpoints overridden at thermostat. |
| Solid Green | Operating on default setpoints. |
| Flashing Blue | Network connection is active. |
| Flashing Red | Information being sent or received over Internet. |
| All colors flash | Duplicate IP address on network. Call tech support for assistance. |

Basic Troubleshooting

Questions...Call Tech Support at 800-292-2444

<u>Symptom</u>	<u>Possible Cause</u>	<u>Solution</u>
No Operation of Heating or Cooling.	1. e-Stat Power Off.	1. Press system On/Off button
	2. No Power to equipment or e-Stat®	2. Check switches, circuit breakers, fuses, gas valve and pilot.
	3. e-Stat at limit temperature	3. Check display to verify the e-stat is set at its Cooling Minimum or Heating Maximum.
Display does not come on during power up.	1.No Power to the e-Stat	1. Verify 24 VAC is present at terminal block by measuring from R to C. If no voltage present, check breakers and fuses.
Fan blows cold air in heating season.	1. Fan ON/AUTO is in wrong position.	1. Move Fan to Auto position by pressing FAN ON/AUTO button.
	2. Heat Fan DIP switch in wrong position.	2. See setting the Heat Fan switch on Page 13.
	3.O/B terminals miswired for heat pump.	3. See the O/B directions on Page 5.
Cooling will not come on.	1. O/B terminals miswired for heat pump.	1. See the O/B directions on Page 5.
	2. Time delay holding Cool OFF.	2. Press the check button to cancel time delays.

Basic Troubleshooting Continued

Questions...Call Tech Support at 800-292-2444

<u>Symptom</u>	<u>Possible Cause</u>	<u>Solution</u>
Display shows remote temp as "00" or "--"	<ol style="list-style-type: none"> 1. There is a Remote Room Sensor installed but the wiring connections are not correct. 2. Humidity sensor saturated or defective. 	<ol style="list-style-type: none"> 1. Check remote sensor and wiring. 2. If problem persists, contact Lightstat support.
The e-Stat powers up correctly, but the display goes blank.	<ol style="list-style-type: none"> 1. Transformer is too small for the installation. 2. The e-Stat resets when outputs come on. 	<ol style="list-style-type: none"> 1. The e-Stat needs a minimum of 20 VAC to operate. You may have to install a larger transformer to provide adequate power to keep the voltage at 24 VAC. 2. Remove all output wires except "R" & "C". Then reconnect the wires one by one. <p>Check field wiring connections and equipment for short or overload.</p>

Appendix A

Using the A1-A2-A3 relay to remotely control an auxiliary load.

The “A” Relay can be programmed via the internet to remotely switch a load such as lighting.

Wire the load such that the A relay is in the “normal” position. This will keep the load ON when the e-Stat A relay is powered off. The web program logic will assume it is wired this way.

To ensure the stat is wired correctly, the state of the relay can be toggled using the following steps:
Press and hold the “READ SENSOR” then “DOWN” button uninterrupted for 10 seconds. Press the up or down button until you reach screen #7, which is indicated by the flashing number. Press the check button to momentarily change the state of the relay. When finished testing, press “READ SENSOR” to exit this mode.

WARNING! FOR CONNECTION TO CLASS 2 CIRCUIT ONLY. DO NOT EXCEED 1 AMP (MAX) @ 24VAC.

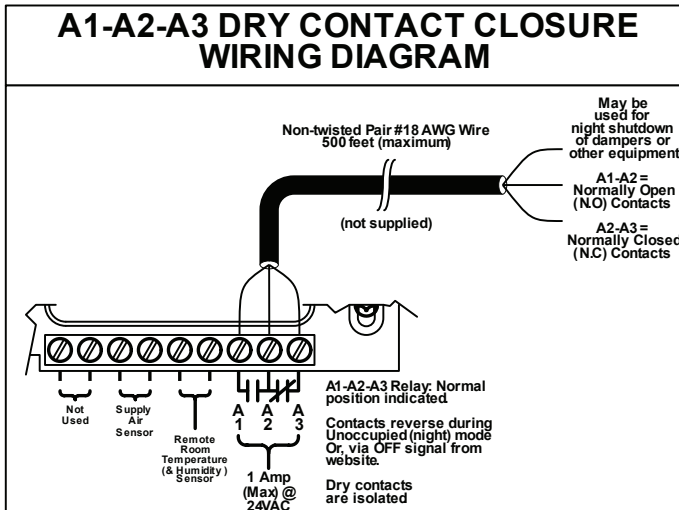

Appendix B

Using the (optional) Humidity Temperature Adjustment

Connecting the RTH sensor allows the e-Stat to read and display relative humidity (%) as well as temperature.

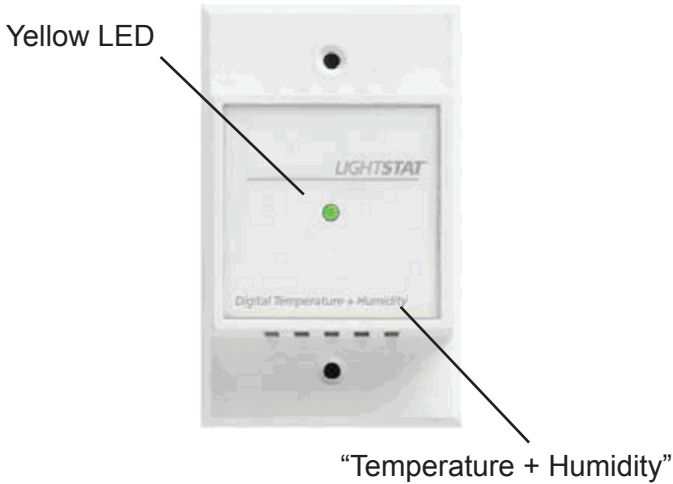

The yellow LED in the center of the sensor will turn on for 3 minutes when the e-Stat is turned on. This helps identify which sensor goes with which e-Stat.

The #18-2 conductor wires which attach the sensor do not require shielding and are not polarized.

Press the "READ SENSOR" Button twice to read % RH from the sensor.

Appendix B continued

Using the (optional) Humidity Temperature Adjustment

Occupant comfort is determined by both temperature and humidity. There are times of the year (especially Spring and Fall) when temperatures may be at the proper setting, but high humidity can cause discomfort.

The e-Stat can automatically lower the programmed cooling setting by 2 °F when a pre-selected Relative Humidity (RH) setting is exceeded.

It lowers the cooling setpoint only when the e-Stat® is satisfied at the programmed cooling setpoint.

You can choose a relative humidity “trigger point” from remotely via the web based interface. (from 45% RH to 70% RH) Let’s choose 55% RH. In this example let’s assume that the e-Stat has been remotely pro-grammed for a 74° F cooling setting.

If the e-Stat is holding the temperature in the space at 74° F and the RH is below 55%, then the cooling would turn off normally. However, if the space temperature is at 74°F and the RH goes above 55%, then the “Cool Set” would automatically drop to 72°F.

The words “REL HUMIDITY” will appear (flashing) in the display for as long as the cooling is operating in this high humidity mode.

Two conditions will stop the extra cooling. First, if the room temperature drops below 72°F, or second, if the relative humidity drops 5% below the “RH trigger point”. In this example, the humidity would have to drop to 50% R.H. in order for the cooling setpoint to revert back to 74°F.

This device complies with Part 15 of the FCC rules. Operation is subject to the following two conditions: (1) this device may not cause harmful interference and (2) this device must accept any interference received, including interference that may cause undesired operation.



Lightstat Limited Lifetime Warranty

Lightstat Inc. warrants that all Hardware Products (Products) sold by it after October 1, 2015 are free of defects in material and workmanship, under normal use and service for as long as the Products are installed in their original installation for the original End User and operator of the Products with the following limitations:

1. In the event of Product discontinuance, warranty support is limited to five (5) years from the announcement of discontinuance.
2. The duration of the warranty period for Products not designed or manufactured by *Lightstat* (e.g. power supplies, Ethernet cables, motion sensors, etc) and mechanical assemblies that are subject to normal wear and tear (e.g. timers, electrical contactors, relays) shall be two (2) years from the time of purchase.
3. This warranty does not apply to any Product which was not operated in accordance with the printed instructions, has been damaged by accident or acts of God or which has been misused, abused or neglected or has been damaged by other cause. This warranty also does not apply to any Product, which was maintained, altered or repaired by anyone other than *Lightstat* or its authorized representatives.
4. This warranty is conditioned upon (a) proper storage, installation, use and maintenance and conformance with any applicable recommendations of *Lightstat* and (b) Customer promptly notifying *Lightstat* of any defects and, if required, promptly making the Product available for correction.

All claims for nonconforming or defective Products must be made within the warranty period. Any claim not made within that period shall be deemed waived and released. *Lightstat's* sole responsibility with respect to such claims shall be, at its option, to repair or replace any Product or component that it determines to be defective. Replaced Products may be refurbished or new equipment at the option of *Lightstat*. Such Product must be removed by the installer and returned to the factory within the applicable warranty period with transportation charges, if any, prepaid, after first obtaining proper authorization and shipping instructions by contacting *Lightstat*. Any repaired or replacement Product shall be warranted for the remaining period of the original Warranty Period. Repair or replacement as provided under this warranty shall be the exclusive remedy of the Customer.

In no event, shall *Lightstat* be responsible for any monetary damage or be liable for any incidental or consequential damages due to any cause whatsoever, including, without limitation, commercial loss or damage resulting from an alleged defect in the Product.

Lightstat does not authorize any other person or organization to assume for it any liability in connection with this Product and any statements or representations made by any other person or organization are void.

EXCEPT FOR THOSE WARRANTIES EXPRESSLY SET FORTH IN THIS AGREEMENT, LIGHTSTAT INC. DISCLAIMS ANY AND ALL OTHER WARRANTIES, EXPRESS IMPLIED, STATUTORY, OR OTHERWISE INCLUDING, BUT NOT LIMITED TO, ALL WARRANTIES OF FITNESS FOR A PARTICULAR PURPOSE OR MERCHANTABILITY. LIGHTSTAT INC. MAKES NO ADDITIONAL EXPRESS OR IMPLIED WARRANTIES EXCEPT TO THE EXTENT, IF ANY, THEY ARE SPECIFICALLY REQUIRED BY LAW.

Some states do not allow the exclusion or limitation of implied warranties or consequential damages, so the above limitations or exclusions may not apply to the purchase of this Product. This warranty gives each original purchaser specific legal rights, and such purchaser may have other rights that vary from state to state.